

2PM 40

S1

Splined shaft DIN 5480
W30x2x14x9g

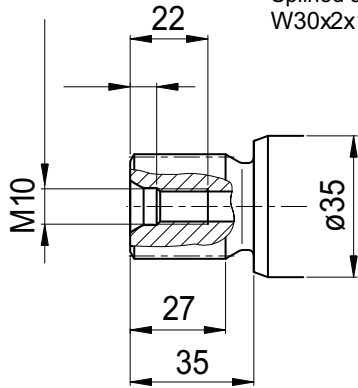

S2

Splined shaft DIN 5480
W25x1.25x18x9g

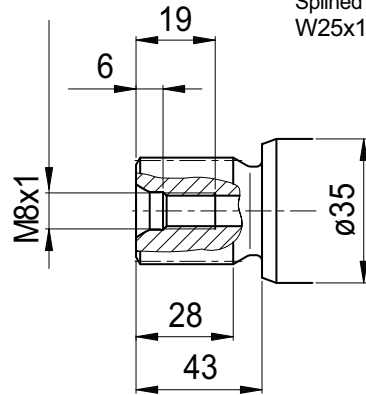

K1

Parallel keyed shaft
DIN 6885, As8x7x40

Key
width 8

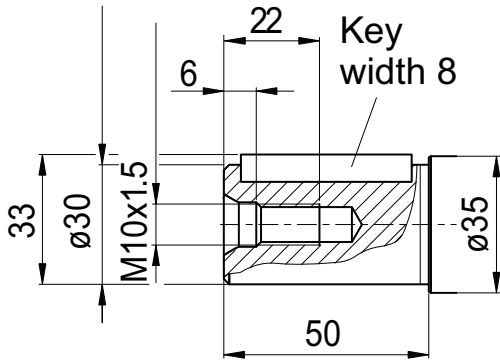

K2

Parallel keyed shaft
DIN 6885, As8x7x40

Key
width 8

