

2PM 108

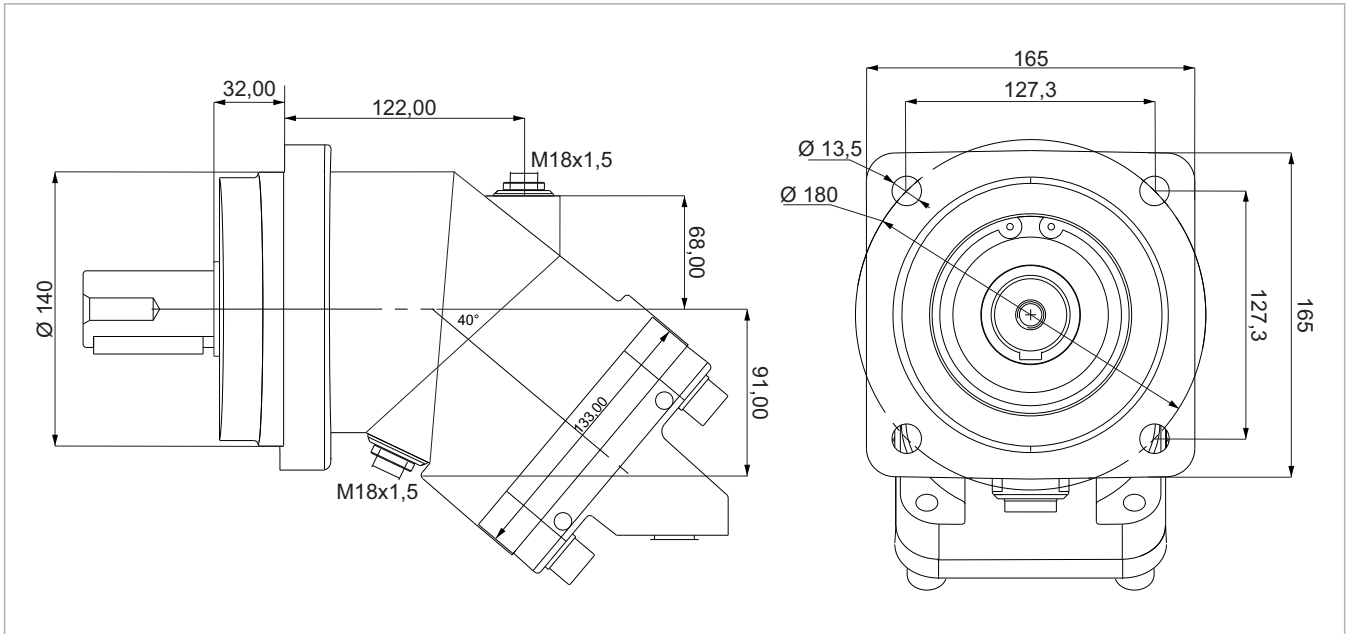

x 1000 rpm	x 1500 rpm	Max. Contin. Pump Speed	Max. Intermit. Pump Speed	Max. Contin. Pressure	Max. Peak Pressure	Torque bar	Torque at 350 bar	Max. Flow	Weight without accessor.	Weight with accessor.	Max. Motor Temp.	Min. Motor Temp.
108,4 cc	162,6 cc	4000 rpm	4400 rpm	400 bar	450 bar	1.69 m.N/bar	600 m.N	433	22,50 kg	23,00 kg	-25°	110°

