

2PE 12 - SAE B - 2 BOLT

SAE B 7/8" 13T-16/32DP

SAE B - 2 BOLT MOUNTING (SAE J744)

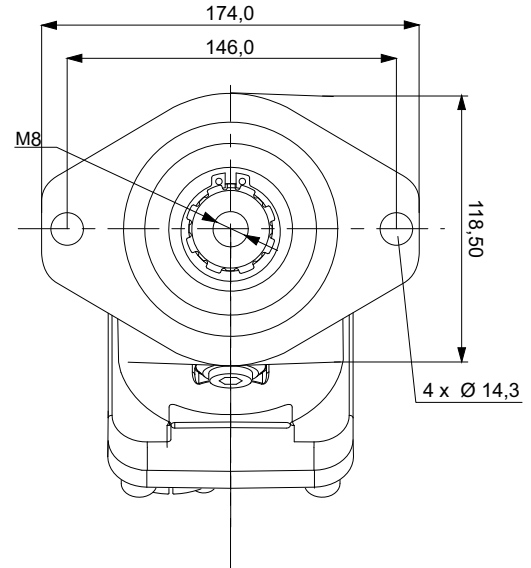
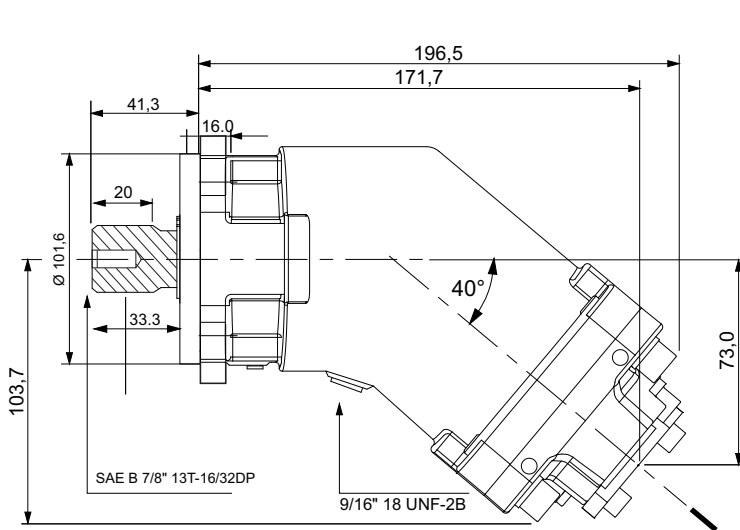

Spline Shaft

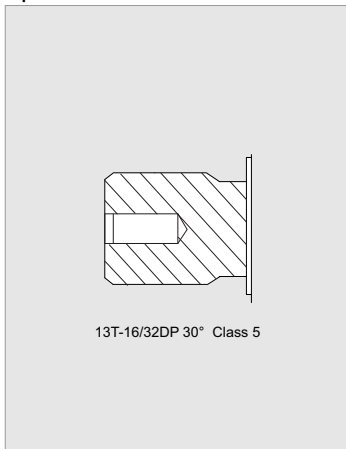

Keyed Shaft

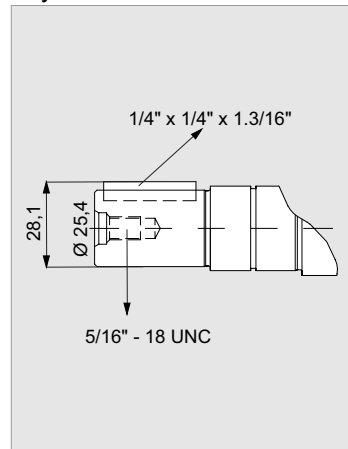

Back Cover

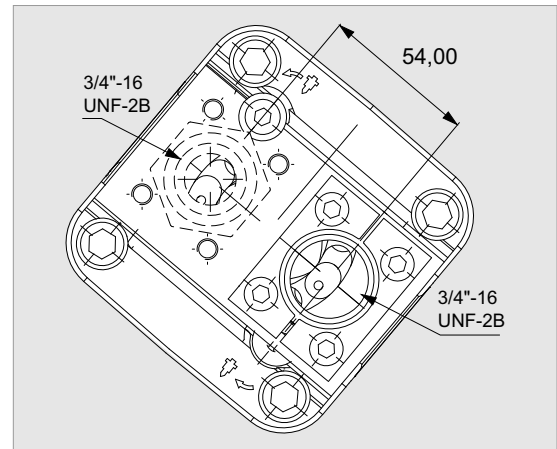

Flow, Speed, Pressure List of 2PE 12

x 1000 rpm	12,00 cc
x 1500 rpm	18,00 cc
Max. Continuous Pump Speed	2300 rpm
Max. Limited Pump Speed	3100 rpm
Max. Continuous Pressure	350 bar
Max. Intermit. Peak Pressure	400 bar
Max. Torque at 350 bar	71 Nm
Weight without inlet fitting	10,00 kg
Weight with inlet fitting	10,40 kg
Rotation	CW-CCW

