

2PBA 50

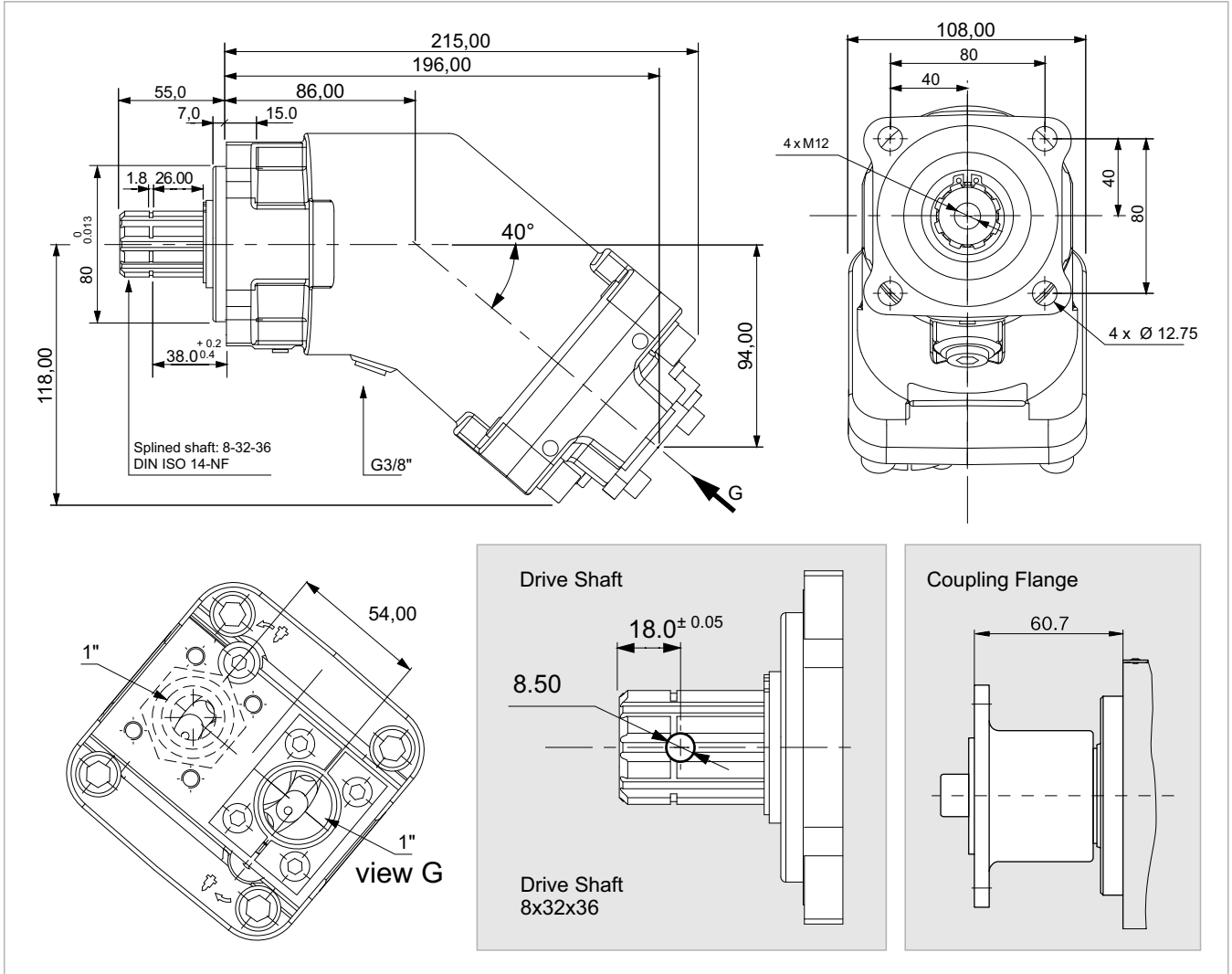

x 1000 rpm	50,00 cc
x 1500 rpm	75,00 cc
Max. Continuous Pump Speed	1900 rpm
Max. Limited Pump Speed	2500 rpm
Max. Continuous Pressure	350 bar
Max. Intermit. Peak Pressure	400 bar
Max. Torque at 350 bar	292 Nm
Weight without inlet fitting	11,00 kg
Weight with inlet fitting	11,40 kg
Torque without inlet fitting	11,72 N.m
Torque with inlet fitting	12,20 N.m
Rotation	CW-CCW
Fluid	Min.B.Hyd.Oil
Inlet & Outlet	1"

Flow, Speed, Pressure List of 2PBA 50

