

2PBM 63

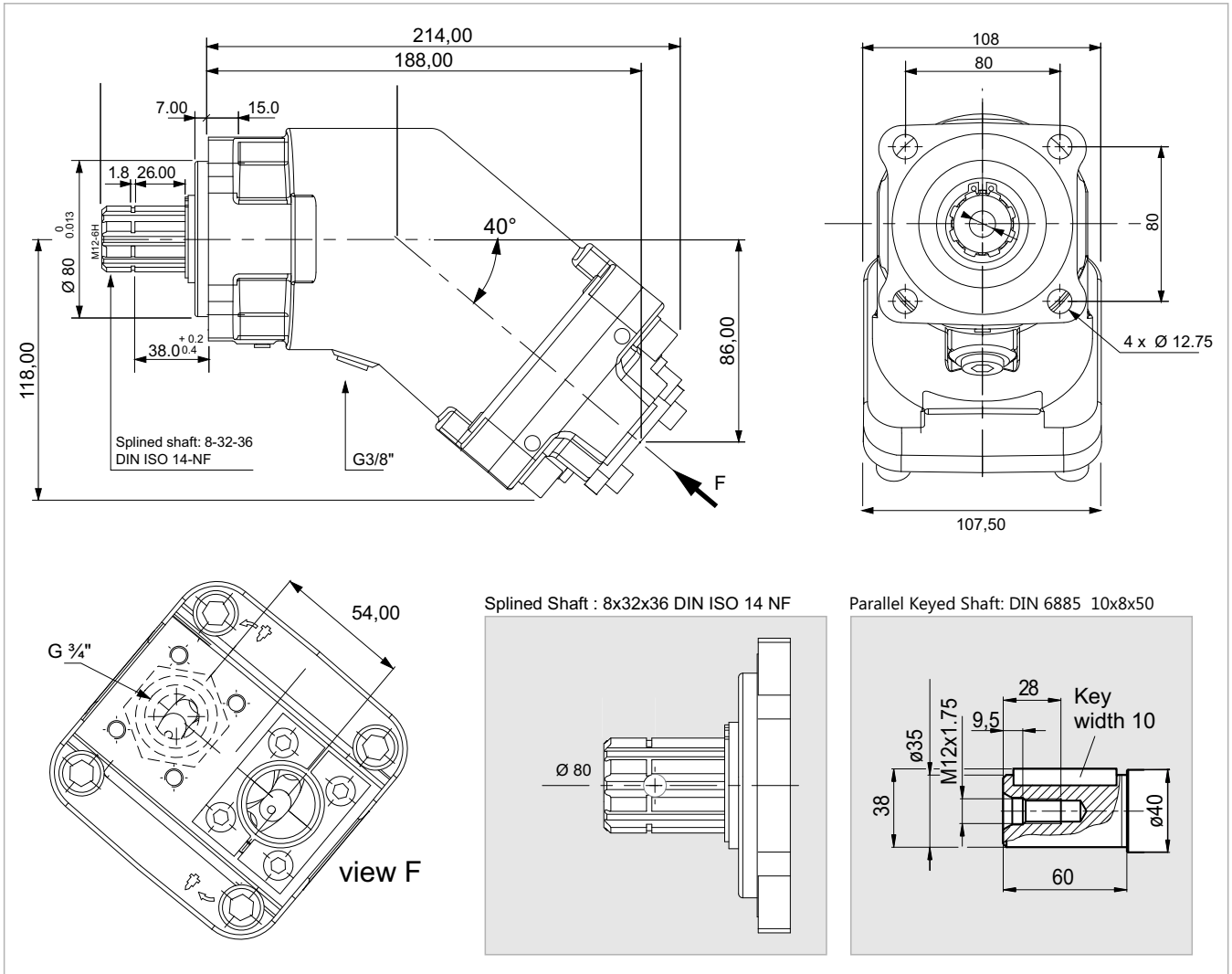

x 1000 rpm	63,00 cc
x 1500 rpm	94,50 cc
Max. Continuous Pump Speed	5000 rpm
Max. Intermittent Pump Speed	5500 rpm
Max. Continuous Pressure	400 bar
Max. Peak Pressure	450 bar
Torque bar	1.00 m.N/bar
Torque at 350 bar	350 m.N
Weight without accessories	12,00 kg
Weight with accessories	12,50 kg
Max. Motor Temperature	-25°
Min. Motor Temperature	110°