

2PM 63

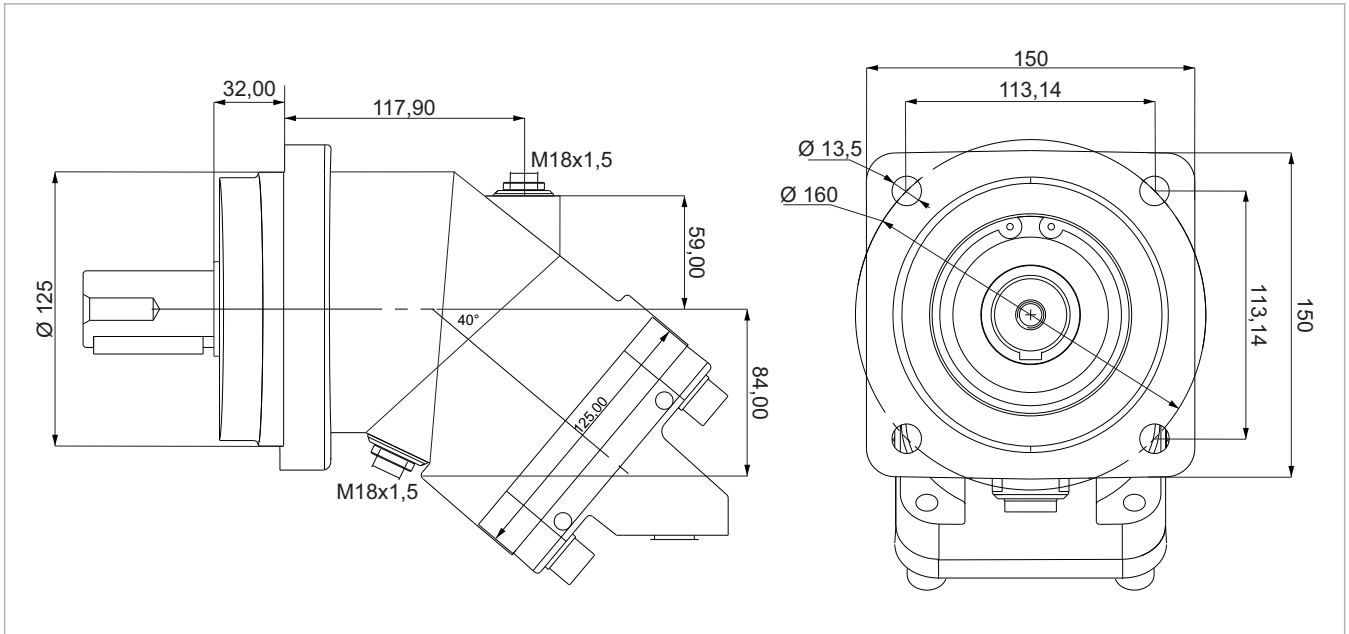

x 1000 rpm	x 1500 rpm	Max. Contin. Pump Speed	Max. Intermit. Pump Speed	Max. Contin. Pressure	Max. Peak Pressure	Torque bar	Torque at 350 bar	Max. Flow	Weight without accessor.	Weight with accessor.	Max. Motor Temp.	Min. Motor Temp.
63,00 cc	94,50 cc	5000 rpm	5500 rpm	400 bar	450 bar	1.00 m.N/bar	350 m.N	315	18,00 kg	18,50 kg	-25°	110°

