

2PBM 32

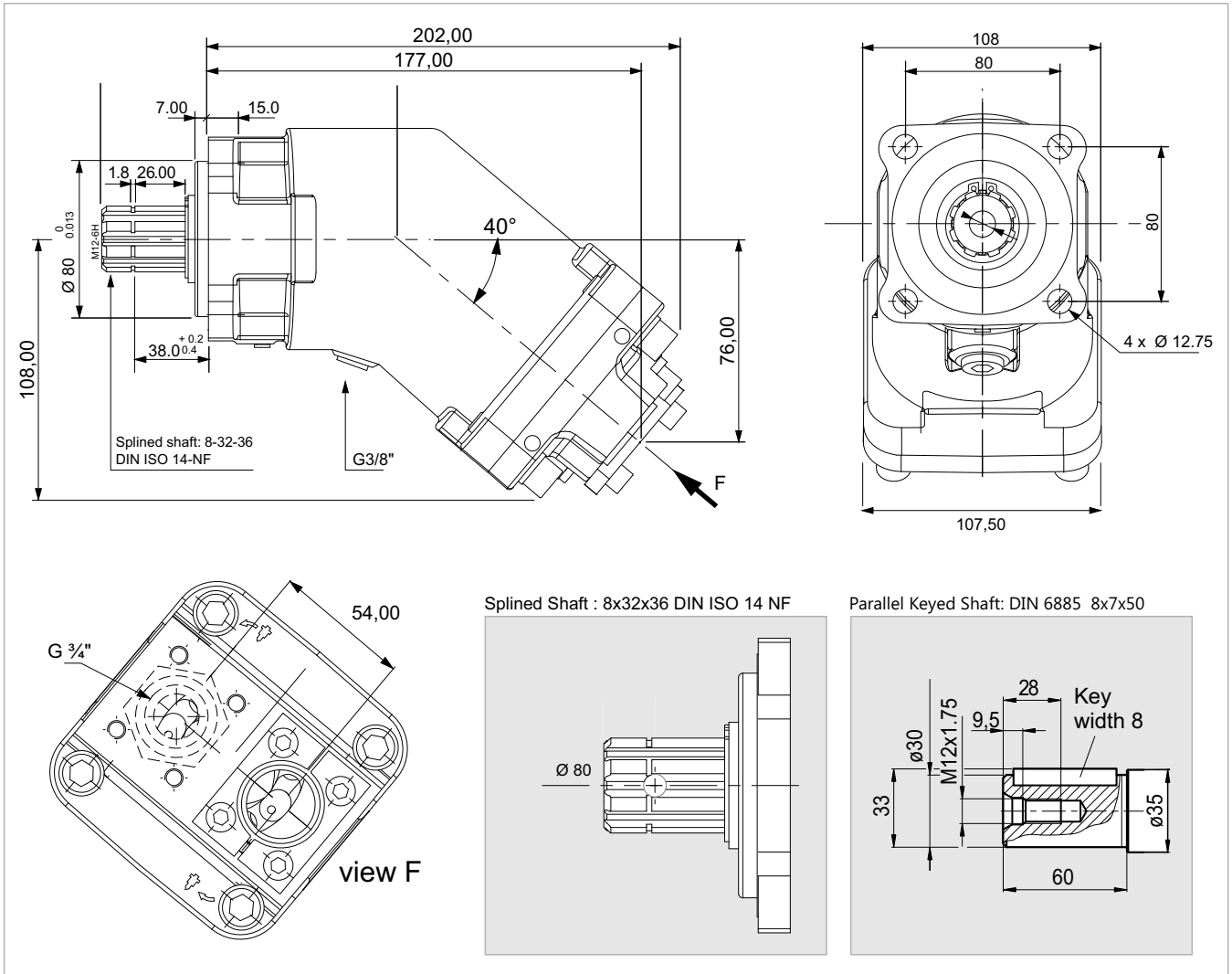

x 1000 rpm	32,00 cc
x 1500 rpm	48,00 cc
Max. Continuous Pump Speed	6250 rpm
Max. Intermittent Pump Speed	6800 rpm
Max. Continuous Pressure	400 bar
Max. Peak Pressure	450 bar
Torque bar	0.51 m.N/bar
Torque at 350 bar	174 m.N
Weight without accessories	11,00 kg
Weight with accessories	11,50 kg
Max. Motor Temperature	-25°
Min. Motor Temperature	110°