

2PM 50

S1

Splined shaft DIN 5480
W30x2x14x9g

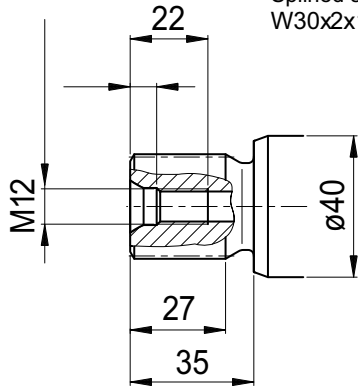

S2

Splined shaft DIN 5480
W35x2x16x9g

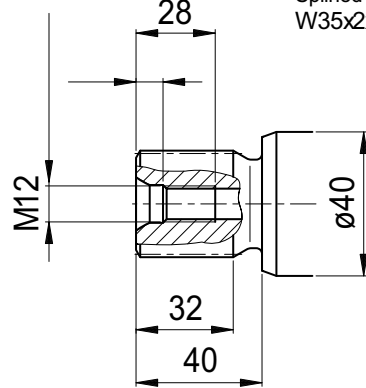

K1

Parallel keyed shaft
DIN 6885, As8x7x50

Key
width 8

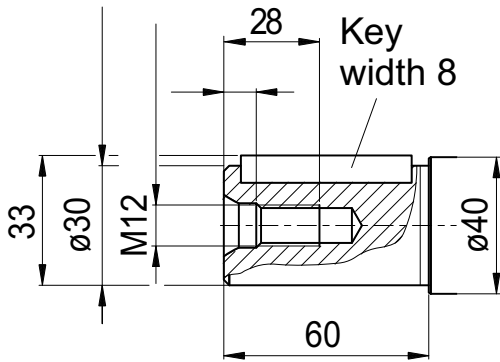

K2

Parallel keyed shaft
DIN 6885, As10x8x50

Key
width 10

