

# 2PM 80

**S1**

Splined shaft DIN 5480  
W40x2x18x9g

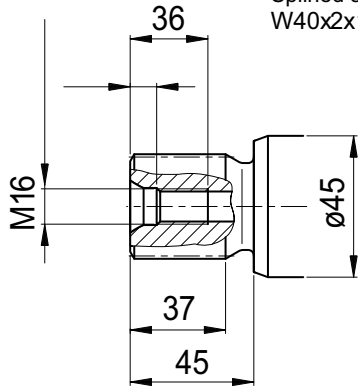

**S2**

Splined shaft DIN 5480  
W35x2x16x9g

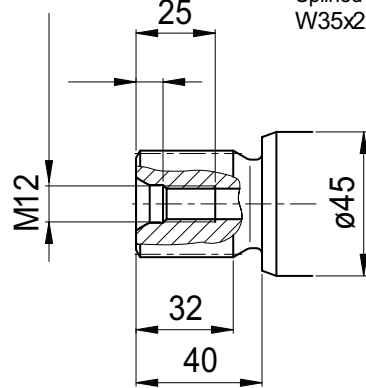

**K1**

Parallel keyed shaft  
DIN 6885, As12x8x56

Key  
width 12

